



1024 x 8 Dual-Port
Static RAM

Features

- 0.8-micron CMOS for optimum speed/power
- Automatic power-down
- TTL-compatible
- Capable of withstanding greater than 2001V electrostatic discharge
- Fully asynchronous operation
- Master CY7C130/CY7C131 easily expands data bus width to 16 or more bits using SLAVE CY7C140/CY7C141
- BUSY output flag on CY7C130/CY7C131; BUSY input on CY7C140/CY7C141
- INT flag for port-to-port communication

Functional Description

The CY7C130/CY7C131/CY7C140/CY7C141 are high-speed CMOS 1K by 8 dual-port static RAMs. Two ports are provided permitting independent access to any location in memory. The CY7C130/CY7C131 can be utilized as either a standalone 8-bit dual-port static RAM or as a master dual-port RAM in conjunction with the CY7C140/CY7C141 slave dual-port device in systems requiring 16-bit or greater word widths. It is the solution to applications requiring shared or buffered data, such as cache memory for DSP, bit-slice, or multiprocessor designs.

Each port has independent control pins; chip enable (CE), write enable (WE), and output enable (OE). Two flags are provided on each port, BUSY and INT. BUSY signals that the port is trying to access the same location currently being accessed by the other port. INT is an interrupt flag indicating that data has been placed in a unique location by the other port. An automatic power-down feature is controlled independently on each port by the chip enable (CE) pin.

The CY7C130 and CY7C140 are available in both 48-pin DIP and 48-pin LCC. The CY7C131 and CY7C141 are available in both 52-pin LCC and PLCC.

A die coat is used to insure alpha immunity.

Logic Block Diagram

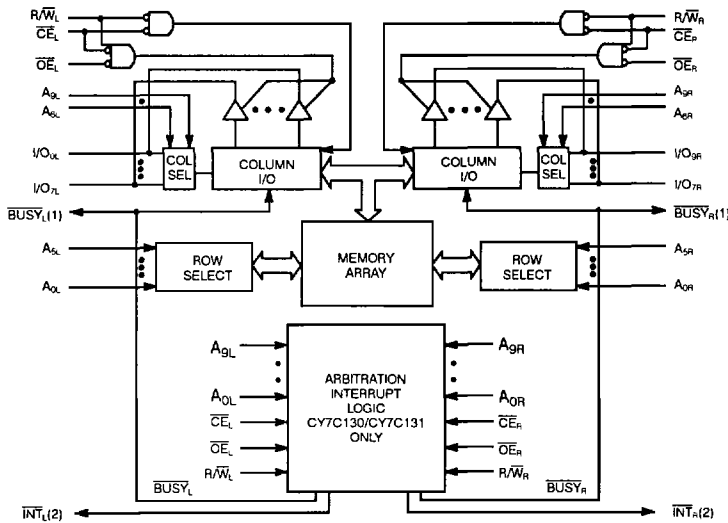

C130-1

Pin Configurations

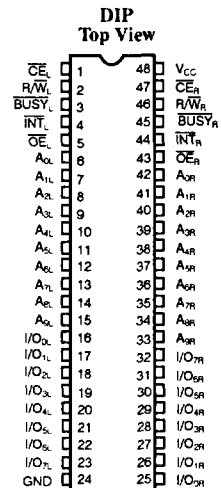

C130-2

Notes:

1. CY7C130/CY7C131 (Master): BUSY is open drain output and requires pull-up resistor. CY7C140/CY7C141 (Slave): BUSY is input.
2. Open drain outputs: pull-up resistor required.

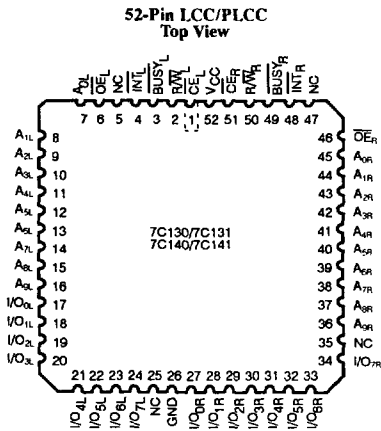
Pin Configurations (continued)

C130-3

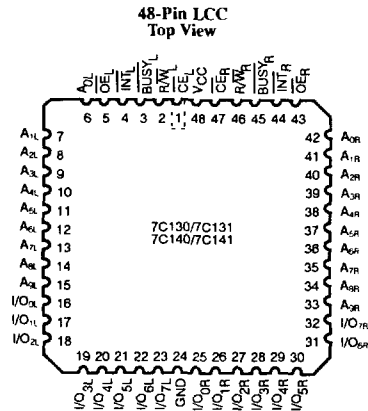

C130-4

2
Selection Guide

		7C130-25 7C131-25 7C140-25 7C141-25	7C130-35 7C131-35 7C140-35 7C141-35	7C130-45 7C131-45 7C140-45 7C141-45	7C130-55 7C131-55 7C140-55 7C141-55
Maximum Access Time (ns)		25	35	45	55
Maximum Operating Current (mA)	Commercial	170	120	90	90
	Military		170	120	120
Maximum Standby Current (mA)	Commercial	65	45	35	35
	Military		65	45	45

Shaded area contains preliminary information.

Maximum Ratings

(Above which the useful life may be impaired. For user guidelines, not tested.)

Storage Temperature - 65°C to + 150°C

Ambient Temperature with

Power Applied - 55°C to + 125°C

 Supply Voltage to Ground Potential
(Pin 48 to Pin 24) - 0.5V to + 7.0V

 DC Voltage Applied to Outputs
in High Z State - 0.5V to + 7.0V

DC Input Voltage - 3.5V to + 7.0V

Output Current into Outputs (Low) 20 mA

 Static Discharge Voltage > 2001V
(per MIL-STD-883, Method 3015)

Latch-Up Current > 200 mA

Operating Range

Range	Ambient Temperature	V _{CC}
Commercial	0°C to + 70°C	5V ± 10%
Military ^[3]	- 55°C to + 125°C	5V ± 10%

Electrical Characteristics Over the Operating Range^[4]

Parameters	Description	Test Conditions	7C130-25 7C131-25 7C140-25 7C141-25		7C130-35 7C131-35 7C140-35 7C141-35		7C130-45, 55 7C131-45, 55 7C140-45, 55 7C141-45, 55		Units
			Min.	Max.	Min.	Max.	Min.	Max.	
V _{OH}	Output HIGH Voltage	V _{CC} = Min., I _{OH} = -4.0 mA	2.4		2.4		2.4		V
V _{OL}	Output LOW Voltage	I _{OL} = 4.0 mA		0.4		0.4		0.4	V
		I _{OL} = 16.0 mA ^[5]		0.5		0.5		0.5	
V _{IH}	Input HIGH Voltage		2.2		2.2		2.2		V
V _{IL}	Input LOW Voltage			0.8		0.8		0.8	V
I _{IX}	Input Load Current	GND ≤ V _I ≤ V _{CC}	-5	+5	-5	+5	-5	+5	μA
I _{OZ}	Output Leakage Current	GND ≤ V _O ≤ V _{CC} , Output Disabled	-5	+5	-5	+5	-5	+5	μA
I _{OS}	Output Short Circuit Current ^[6]	V _{CC} = Max., V _{OUT} = GND		-350		-350		-350	mA
I _{CC}	V _{CC} Operating Supply Current	CE = V _{IL} Outputs Open f = f _{MAX}	Com'l	170		120		90	mA
			Mil			170		120	mA
I _{SB1}	Standby Current Both Ports, TTL Inputs	CE _L and CE _R ≥ V _{IH} f = f _{MAX}	Com'l	65		45		35	mA
			Mil			65		45	mA
I _{SB2}	Standby Current One Port, TTL Inputs	CE _L and CE _R ≥ V _{IH} Active Port Outputs Open f = f _{MAX}	Com'l	115		90		75	mA
			Mil			115		90	mA
I _{SB3}	Standby Current Both Ports, CMOS Inputs	Both Ports CE _L and CE _R ≥ V _{CC} - 0.2V V _{IN} ≥ V _{CC} - 0.2V or V _{IN} ≤ 0.2V, f = 0	Com'l	15		15		15	mA
			Mil			15		15	mA
I _{SB4}	Standby Current One Port, CMOS Inputs	One Port CE _L or CE _R ≥ V _{CC} - 0.2V, V _{IN} ≥ V _{CC} - 0.2V or V _{IN} ≤ 0.2V, Active Ports Outputs Open, f = f _{MAX}	Com'l	105		85		70	mA
			Mil			105		85	mA

Shaded area contains preliminary information.

Capacitance^[7]

Parameters	Description	Test Conditions	Max.	Units
C _{IN}	Input Capacitance	T _A = 25°C, f = 1 MHz, V _{CC} = 5.0V	10	pF
C _{OUT}	Output Capacitance		10	pF

Notes:

- T_A is the "instant on" case temperature
- See the last page of this specification for Group A subgroup testing information.
- BUSY and INT pins only.
- Duration of the short circuit should not exceed 30 seconds.
- Tested initially and after any design or process changes that may affect these parameters.
- Test conditions assume signal transition times of 5 ns or less, timing reference levels of 1.5V, input pulse levels of 0 to 3.0V and output loading of the specified I_{OL}/I_{OH}, and 30-pF load capacitance.
- t_{HZCE} and t_{HZWE} are tested with C_L = 5pF as in part (b) of AC Test Loads. Transition is measured ±500 mV from steady state voltage.
- At any given temperature and voltage condition, t_{HZ} is less than t_{LZ} for any given device.
- The internal write time of the memory is defined by the overlap of CS LOW and WE LOW. Both signals must be low to initiate a write and either signal can terminate a write by going high. The data input set-up and hold timing should be referenced to the rising edge of the signal that terminates the write.

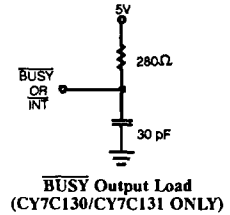
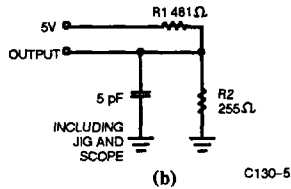
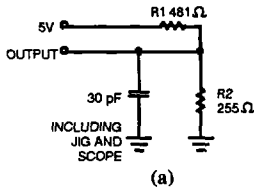
AC Test Loads and Waveforms

Equivalent to: **THEVENIN EQUIVALENT**
OUTPUT ——— 167Ω ——— 1.73V

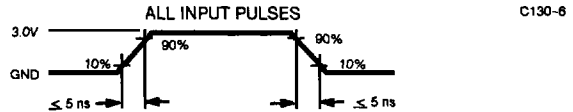
Switching Characteristics Over the Operating Range^[4, 8]

Parameters	Description	7C130-25 7C131-25 7C140-25 7C141-25		7C130-35 7C131-35 7C140-35 7C141-35		7C130-45 7C131-45 7C140-45 7C141-45		7C130-55 7C131-55 7C140-55 7C141-55		Units
		Min.	Max.	Min.	Max.	Min.	Max.	Min.	Max.	
READ CYCLE										
t_{RC}	Read Cycle Time	25		35		45		55		ns
t_{AA}	Address to Data Valid		25		35		45		55	ns
t_{OHA}	Data Hold from Address Change	0		0		0		0		ns
t_{ACE}	\overline{CE} LOW to Data Valid		30		35		45		55	ns
t_{DOE}	\overline{OE} LOW to Data Valid		15		20		25		25	ns
t_{LZOE}	\overline{OE} LOW to Low Z	3		3		3		3		ns
t_{HZOE}	\overline{OE} HIGH to High Z ^[9]		15		20		20		25	ns
t_{LZCE}	\overline{CE} LOW to Low Z ^[10]	5		5		5		5		ns
t_{HZCE}	\overline{CE} HIGH to High Z ^[9, 10]		15		20		20		25	ns
t_{PU}	\overline{CE} LOW to Power-Up	0		0		0		0		ns
t_{PD}	\overline{CE} HIGH to Power-Down		25		35		35		35	ns
WRITE CYCLE^[11]										
t_{WC}	Write Cycle Time	25		35		45		55		ns
t_{SCE}	\overline{CE} LOW to Write End	20		30		35		40		ns
t_{AW}	Address Set-Up to Write End	20		30		35		40		ns
t_{HA}	Address Hold from Write End	2		2		2		2		ns
t_{SA}	Address Set-Up to Write Start	0		0		0		0		ns
t_{PWE}	\overline{WE} Pulse Width	20		25		30		30		ns
t_{SD}	Data Set-Up to Write End	15		15		20		20		ns
t_{HD}	Data Hold from Write End	0		0		0		0		ns
t_{HZWE}	\overline{WE} HIGH to High Z		15		20		20		25	ns
t_{LZWE}	\overline{WE} HIGH to Low Z	0		0		0		0		ns

Shaded area contains preliminary information.

Switching Characteristics Over the Operating Range^{14, 81} (Continued)

Parameters	Description	7C130-25 7C131-25 7C140-25 7C141-25		7C130-35 7C131-35 7C140-35 7C141-35		7C130-45 7C131-45 7C140-45 7C141-45		7C130-55 7C131-55 7C140-55 7C141-55		Units
		Min.	Max.	Min.	Max.	Min.	Max.	Min.	Max.	
BUSY/INTERRUPT TIMING										
t _{B\overline{L}A}	$\overline{\text{BUSY}}$ LOW from Address Match		20			45		50		ns
t _{B\overline{H}A}	$\overline{\text{BUSY}}$ HIGH from Address Mismatch ^[12]		20		35		45		55	ns
t _{B\overline{L}C}	$\overline{\text{BUSY}}$ LOW from $\overline{\text{CE}}$ LOW		20		35		45		25	ns
t _{B\overline{H}C}	$\overline{\text{BUSY}}$ HIGH from $\overline{\text{CE}}$ HIGH ^[12]		20		20		25		25	ns
t _{PS}	Port Set Up for Priority	5		5		5		5		ns
t _{WB^[13]}	$\overline{\text{WE}}$ LOW after $\overline{\text{BUSY}}$ LOW	0		0		0		0		ns
t _{WH}	$\overline{\text{WE}}$ HIGH after $\overline{\text{BUSY}}$ HIGH	20		30		35		35		ns
t _{BDD}	$\overline{\text{BUSY}}$ HIGH to Valid Data		25		35		45		45	ns
t _{DDD}	Write Data Valid to Read Data Valid		Note 14		Note 14		Note 14		Note 14	ns
t _{WDD}	Write Pulse to Data Delay		Note 14		Note 14		Note 14		Note 14	ns
INTERRUPT TIMING										
t _{WINS}	$\overline{\text{WE}}$ to $\overline{\text{INTERRUPT}}$ Set Time		25		25		35		45	ns
t _{EINS}	$\overline{\text{CE}}$ to $\overline{\text{INTERRUPT}}$ Set Time		25		25		35		45	ns
t _{INS}	Address to $\overline{\text{INTERRUPT}}$ Set Time		25		25		35		45	ns
t _{OINR}	$\overline{\text{OE}}$ to $\overline{\text{INTERRUPT}}$ Reset Time ^[12]		25		25		35		45	ns
t _{EINR}	$\overline{\text{CE}}$ to $\overline{\text{INTERRUPT}}$ Reset Time ^[12]		25		25		35		45	ns
t _{INR}	Address to $\overline{\text{INTERRUPT}}$ Reset Time ^[12]		25		25		35		45	ns

Shaded area contains preliminary information.

Notes:

12. These parameters are measured from the input signal changing, until the output pin goes to a high-impedance state.
13. CY7C140/CY7C141 only.
14. A write operation on Port A, where Port A has priority, leaves the data on Port B's outputs undisturbed until one access time after one of the following:
 - A. $\overline{\text{BUSY}}$ on Port B goes HIGH.
 - B. Port B's address is toggled.
 - C. $\overline{\text{CE}}$ for Port B is toggled.
 - D. $\overline{\text{WE}}$ for Port B is toggled.
15. $\overline{\text{WE}}$ is HIGH for read cycle.
16. Device is continuously selected, $\overline{\text{CS}} = V_{\text{IL}}$ and $\overline{\text{OE}} = V_{\text{IL}}$.
17. Address valid prior to or coincident with $\overline{\text{CE}}$ transition LOW.
18. Data I/O pins enter high-impedance state as shown, when $\overline{\text{OE}}$ is held LOW during write.

Switching Waveforms

Read Cycle No. 1^[15, 16]

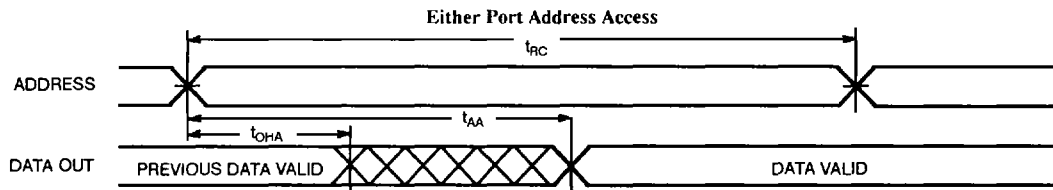

C130-7

Switching Waveforms (continued)

Read Cycle No. 2^[15, 17]

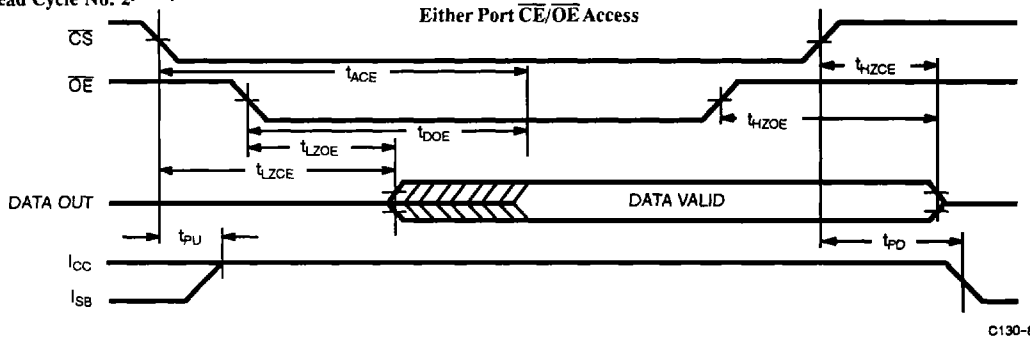

Timing Waveform of Read with \overline{BUSY} ^[15]

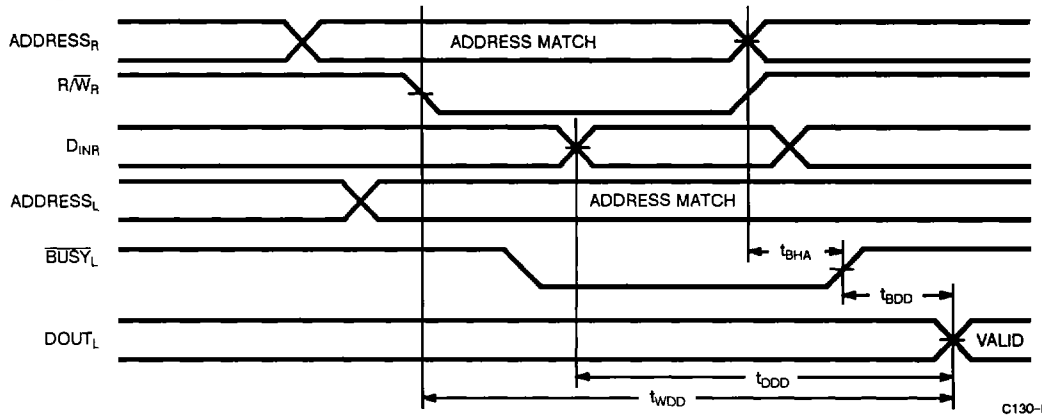

Write Cycle No. 1^[11, 18]

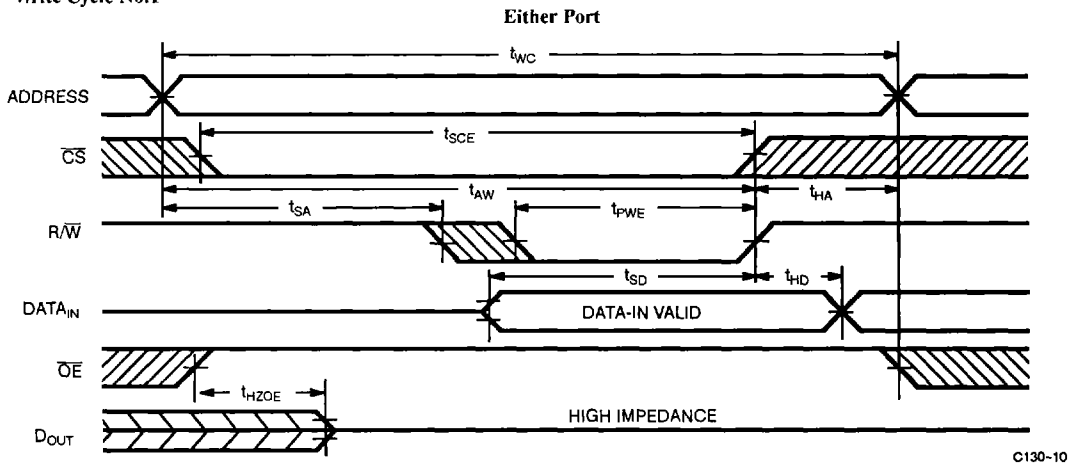

Switching Waveforms (continued)

Write Cycle No. 2 ^[11, 18]

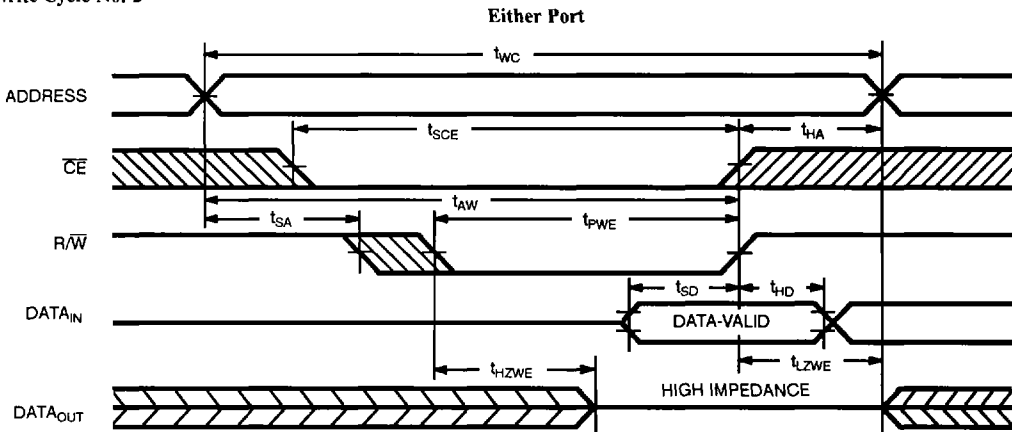

C130-11

Busy Timing Diagram No. 1 (\overline{CE} Arbitration)

\overline{CE}_L Valid First:

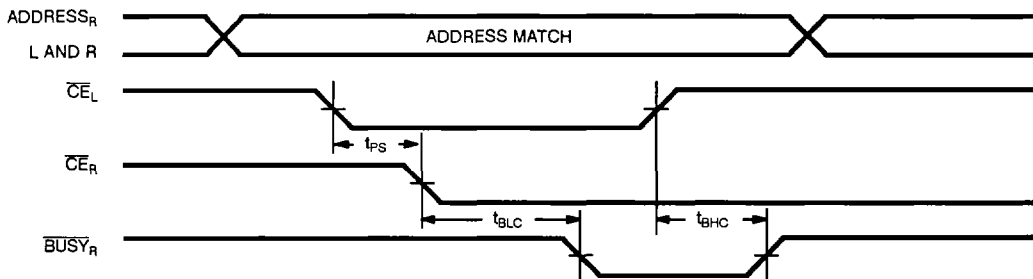

C130-12

\overline{CE}_R Valid First:

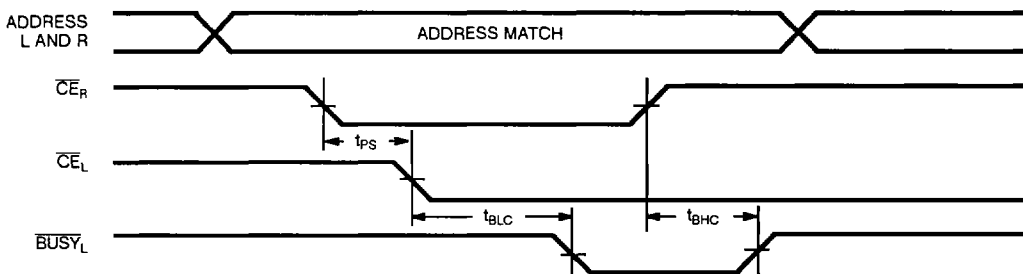

C130-13

Switching Waveforms (continued)

Busy Timing Diagram No. 2 (Address Arbitration)

Left Address Valid First:

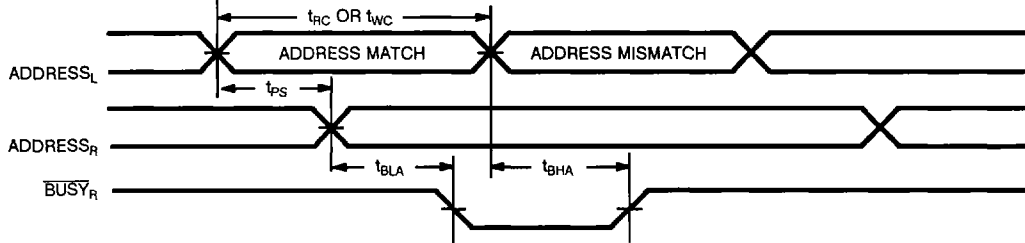

C130-14

Right Address Valid First:

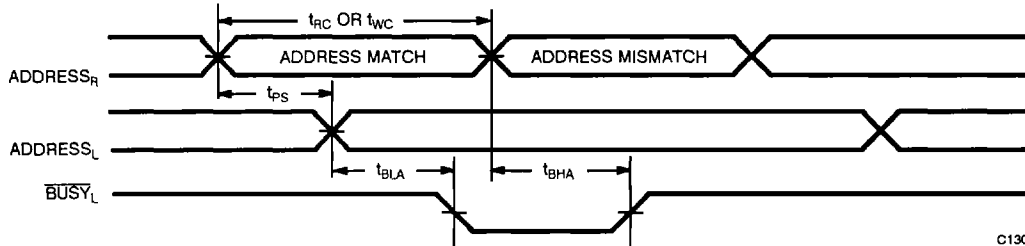

C130-15

Busy Timing Diagram No. 3

Write with $\overline{\text{BUSY}}$ (Slave: CY7C140/CY7C141)

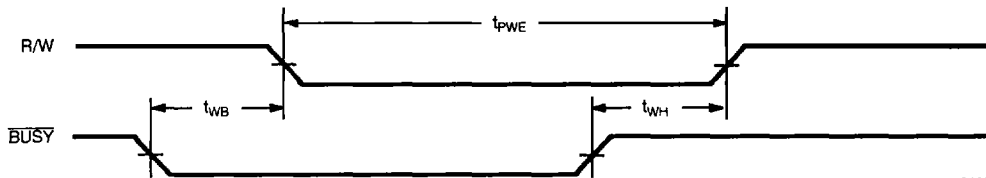

C130-18

Switching Waveforms (continued)

Interrupt Timing Diagrams

Left Side Sets \overline{INT}_R :

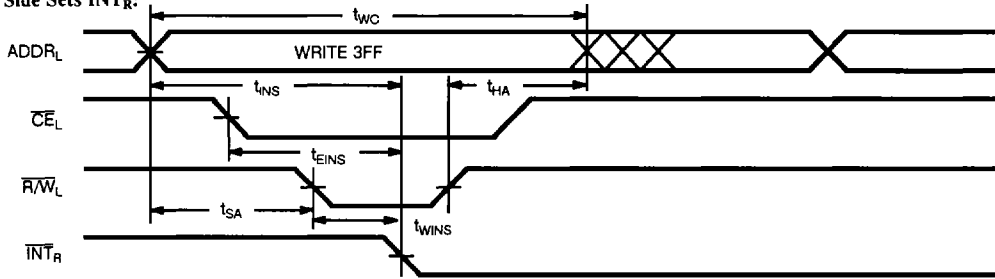

Right Side Clears \overline{INT}_R :

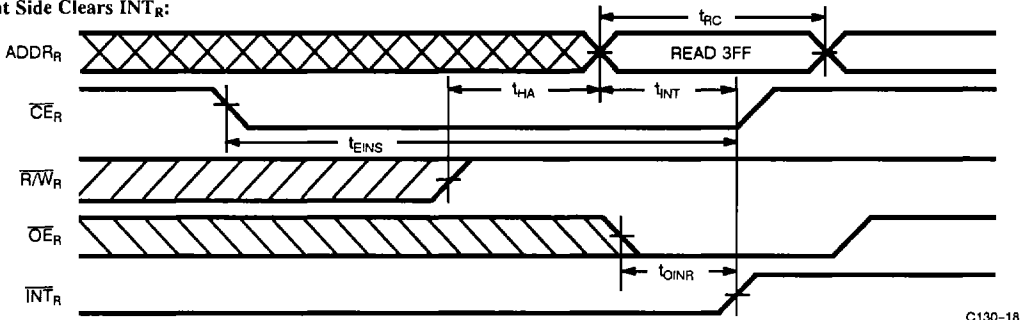

Right Side Sets \overline{INT}_L :

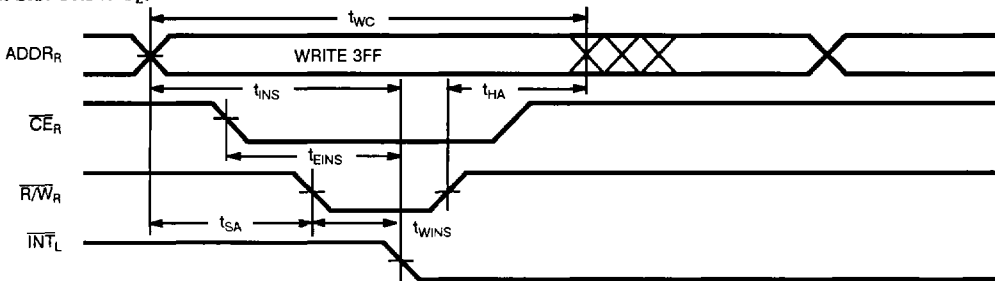

Left Side Clears \overline{INT}_L :

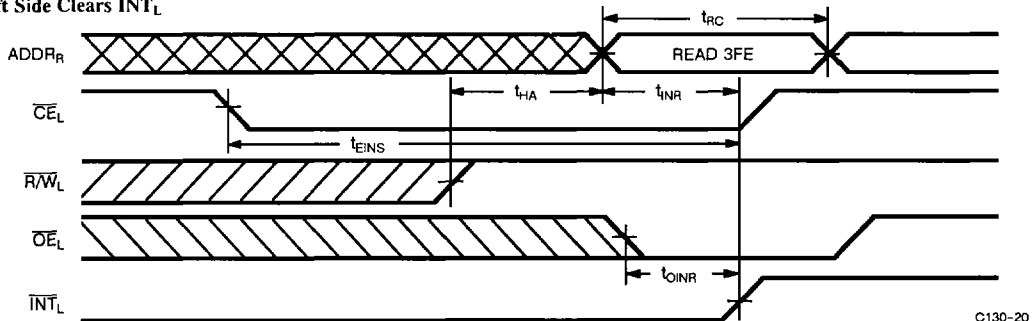

Typical DC and AC Characteristics

2

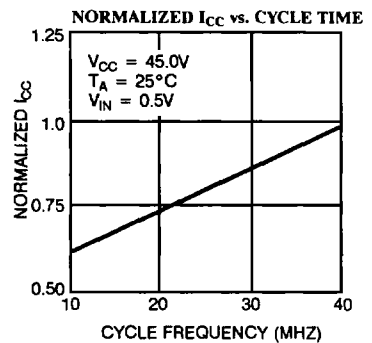
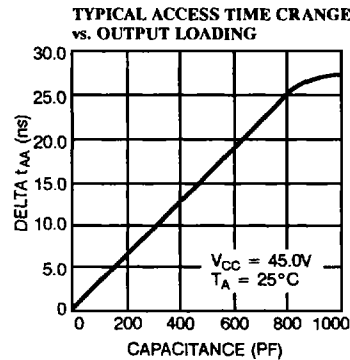
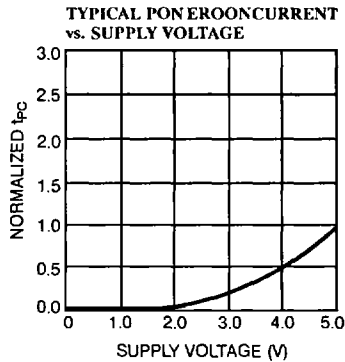
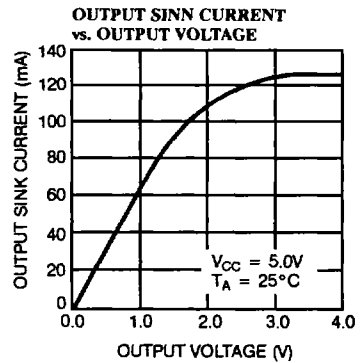
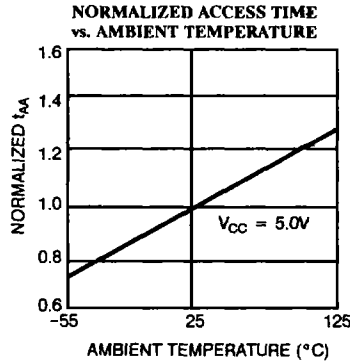
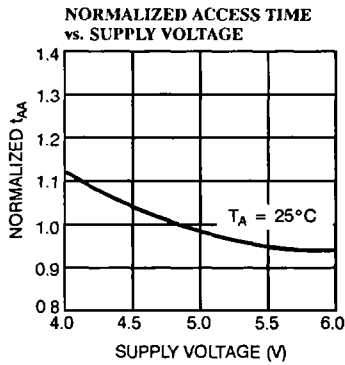
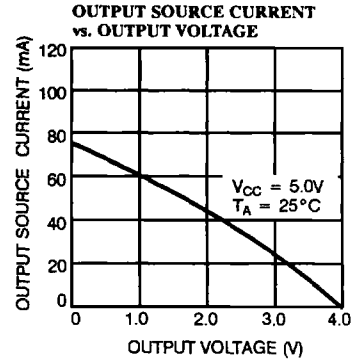
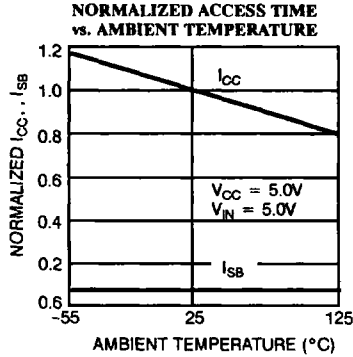
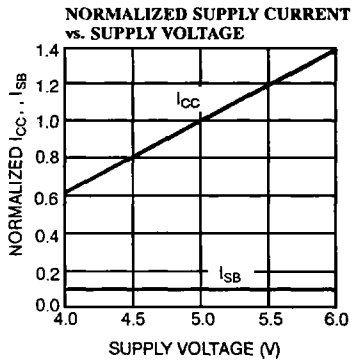

Ordering Information

Speed (ns)	Ordering Code	Package Type	Operating Range
25	CY7C130-25PC	P25	Commercial
	CY7C130-25DC	D26	
	CY7C130-25LC	L68	
35	CY7C130-35PC	P25	Commercial
	CY7C130-35DC	D26	
	CY7C130-35LC	L68	
	CY7C130-35DMB	D26	Military
	CY7C130-35LMB	L68	
45	CY7C130-45PC	P25	Commercial
	CY7C130-45DC	D26	
	CY7C130-45LC	L68	
	CY7C130-45DMB	D26	Military
	CY7C130-45LMB	L68	
55	CY7C130-55PC	P25	Commercial
	CY7C130-55DC	D26	
	CY7C130-55LC	L68	
	CY7C130-55DMB	D26	Military
	CY7C130-55LMB	L68	

Speed (ns)	Ordering Code	Package Type	Operating Range
25	CY7C140-25PC	P25	Commercial
	CY7C140-25DC	D26	
	CY7C140-25LC	L68	
35	CY7C140-35PC	P25	Commercial
	CY7C140-35DC	D26	
	CY7C140-35LC	L68	
	CY7C140-35DMB	D26	Military
	CY7C140-35LMB	L68	
45	CY7C140-45PC	P25	Commercial
	CY7C140-45DC	D26	
	CY7C140-45LC	L68	
	CY7C140-45DMB	D26	Military
	CY7C140-45LMB	L68	
55	CY7C140-55PC	P25	Commercial
	CY7C140-55DC	D26	
	CY7C140-55LC	L68	
	CY7C140-55DMB	D26	Military
	CY7C140-55LMB	L68	

Speed (ns)	Ordering Code	Package Type	Operating Range
25	CY7C131-25LC	L69	Commercial
	CY7C131-25JC	J69	
35	CY7C131-35LC	L69	Commercial
	CY7C131-35JC	J69	
	CY7C131-35LMB	L69	Military
45	CY7C131-45LC	L69	Commercial
	CY7C131-45JC	J69	
	CY7C131-45LMB	L69	Military
55	CY7C131-55LC	L69	Commercial
	CY7C131-55JC	J69	
	CY7C131-55LMB	L69	Military

Speed (ns)	Ordering Code	Package Type	Operating Range
25	CY7C141-25LC	L69	Commercial
	CY7C141-25JC	J69	
35	CY7C141-35LC	L69	Commercial
	CY7C141-35JC	J69	
	CY7C141-35LMB	L69	Military
45	CY7C141-45LC	L69	Commercial
	CY7C141-45JC	J69	
	CY7C141-45LMB	L69	Military
55	CY7C141-55LC	L69	Commercial
	CY7C141-55JC	L69	
	CY7C141-55LMB	L69	Military

Shaded area contains preliminary information.

MILITARY SPECIFICATIONS
Group A Subgroup Testing
DC Characteristics

Parameters	Subgroups
V _{OH}	1, 2, 3
V _{OL}	1, 2, 3
V _{IH}	1, 2, 3
V _{IL Max.}	1, 2, 3
I _{IX}	1, 2, 3
I _{OZ}	1, 2, 3
I _{OS}	1, 2, 3
I _{CC}	1, 2, 3
I _{SB1}	1, 2, 3
I _{SB2}	1, 2, 3
I _{SB3}	1, 2, 3
I _{SB4}	1, 2, 3

Switching Characteristics

Parameters	Subgroups
READ CYCLE	
t _{RC}	7, 8, 9, 10, 11
t _{AA}	7, 8, 9, 10, 11
t _{OHA}	7, 8, 9, 10, 11
t _{ACE}	7, 8, 9, 10, 11
t _{DOE}	7, 8, 9, 10, 11
WRITE CYCLE	
t _{WC}	7, 8, 9, 10, 11
t _{SCE}	7, 8, 9, 10, 11
t _{AW}	7, 8, 9, 10, 11
t _{HA}	7, 8, 9, 10, 11
t _{SA}	7, 8, 9, 10, 11
t _{PWE}	7, 8, 9, 10, 11
t _{SD}	7, 8, 9, 10, 11
t _{HD}	7, 8, 9, 10, 11

Parameters	Subgroups
BUSY/INTERRUPT TIMING	
t _{BLA}	7, 8, 9, 10, 11
t _{BHA}	7, 8, 9, 10, 11
t _{BLC}	7, 8, 9, 10, 11
t _{BHC}	7, 8, 9, 10, 11
t _{PS}	7, 8, 9, 10, 11
t _{WINS}	7, 8, 9, 10, 11
t _{EINS}	7, 8, 9, 10, 11
t _{JNS}	7, 8, 9, 10, 11
t _{OINR}	7, 8, 9, 10, 11
t _{EINR}	7, 8, 9, 10, 11
t _{INR}	7, 8, 9, 10, 11
BUSY TIMING	
t _{WB} ^[19]	7, 8, 9, 10, 11
t _{WH}	7, 8, 9, 10, 11
t _{BDD}	7, 8, 9, 10, 11
t _{DDD}	7, 8, 9, 10, 11
t _{WDD}	7, 8, 9, 10, 11

Note:
19. CY7C140 only.